

# The past 10 years of Automotive Vulnerabilities

Martin Schmiedecker

# \$whoami

- Bosch Engineering by day
- Online privacy by night
- Digital forensics in between
- Meme artist
- Goes by [@Fr333k](#)
- References = klick the picture



# Goal of this talk

- VERY busy area of research
- Identify the most relevant ones
- Your mileage may vary

## Objectives:

- Real-world, not theoretical
- Bypassing security goal

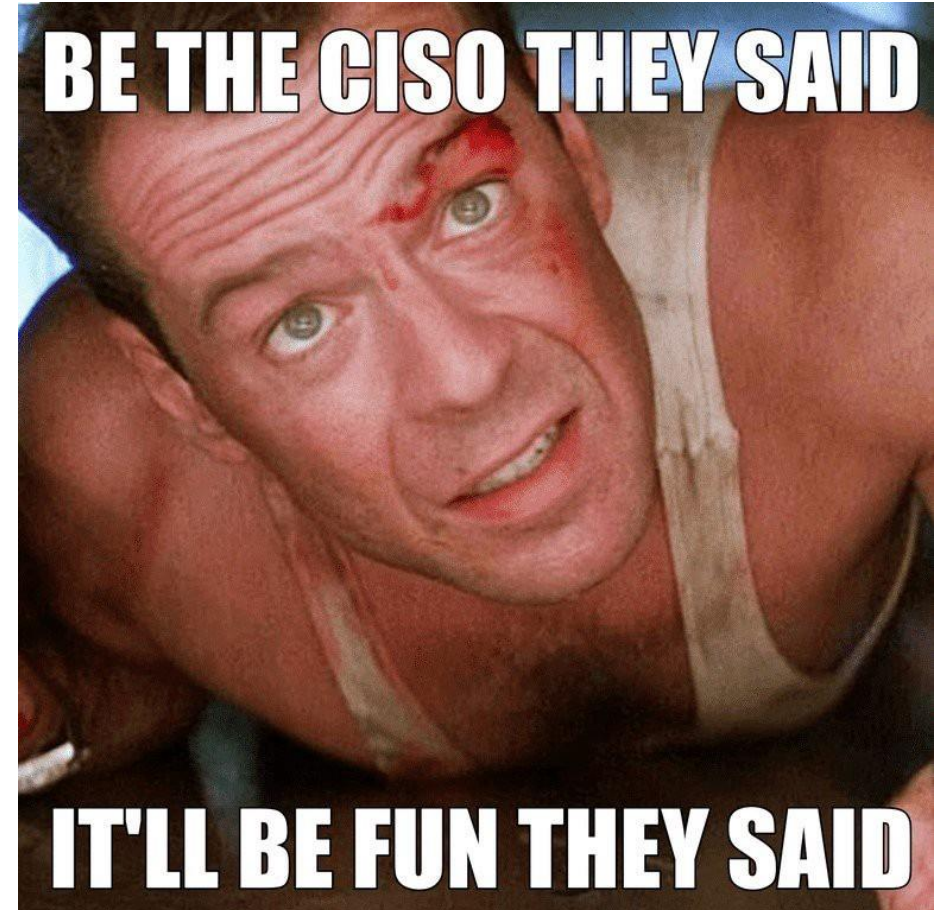

# What to expect

- Public stuff
- Just a selection

Basically, two groups:

- Hackers, for the fame
- Companies, for the fame (& fortune)



# Not included

- Automotive basics
- APIs and backend security
- Charger communication
- Tuning
- Immobilizers
- Relay attacks
- Locking i.e., Megamos, HiTag2





# 2010 Koscher et. al

- Paper at IEEE Security & Privacy 2010
- Replay, inject & fuzz CAN messages
- Kill engine, apply brakes, disable brakes

## Experimental security analysis of a modern automobile

[K Koscher](#), [A Czeskis](#), [F Roesner](#)... - ... on [security](#) and ..., 2010 - [ieeexplore.ieee.org](#)

Modern automobiles are no longer mere mechanical devices; they are pervasively monitored and controlled by dozens of digital computers coordinated via internal vehicular ...

☆ [Speichern](#) [Zitieren](#) Zitiert von: 2048 [Ähnliche Artikel](#) [Alle 49 Versionen](#)



2010 Koscher et. al



# 2011 Checkoway et. al

- Paper at USENIX Security 2011
- Command and control using IRC
- Location tracking
- In-vehicular audio exfiltration
- CD firmware update unsigned
- Buffer overflow in WMA parser
- Remote exploit in calling telematics unit





# 2013 Houtenbos/Kloosterman

- *Tinfoil Attack* against BMW ConnectedDrive
- Students from University of Amsterdam
- HTTP proxy with plain (base64) authentication
- Dedicated APN with 160.50.0.0/16
- UserAgent: Firefox 3.5 on Win7?



# 2015 ADAC/Spaar

- Cinterion GPRS/Edge modem in *Combobox*
- Fake base station as IMSI catcher
- Fleet keys for SMS encryption
- HTTP GET for unlocking
- Unauthenticated XML for config updates
- 2.2 million vehicles affected (BMW, Mini, Rolls Royce)



# 2015 GM OnStar

- GM hacked itself, kind-a
- Remote software update
- With no previous capability
- About 2 million OnStar 8

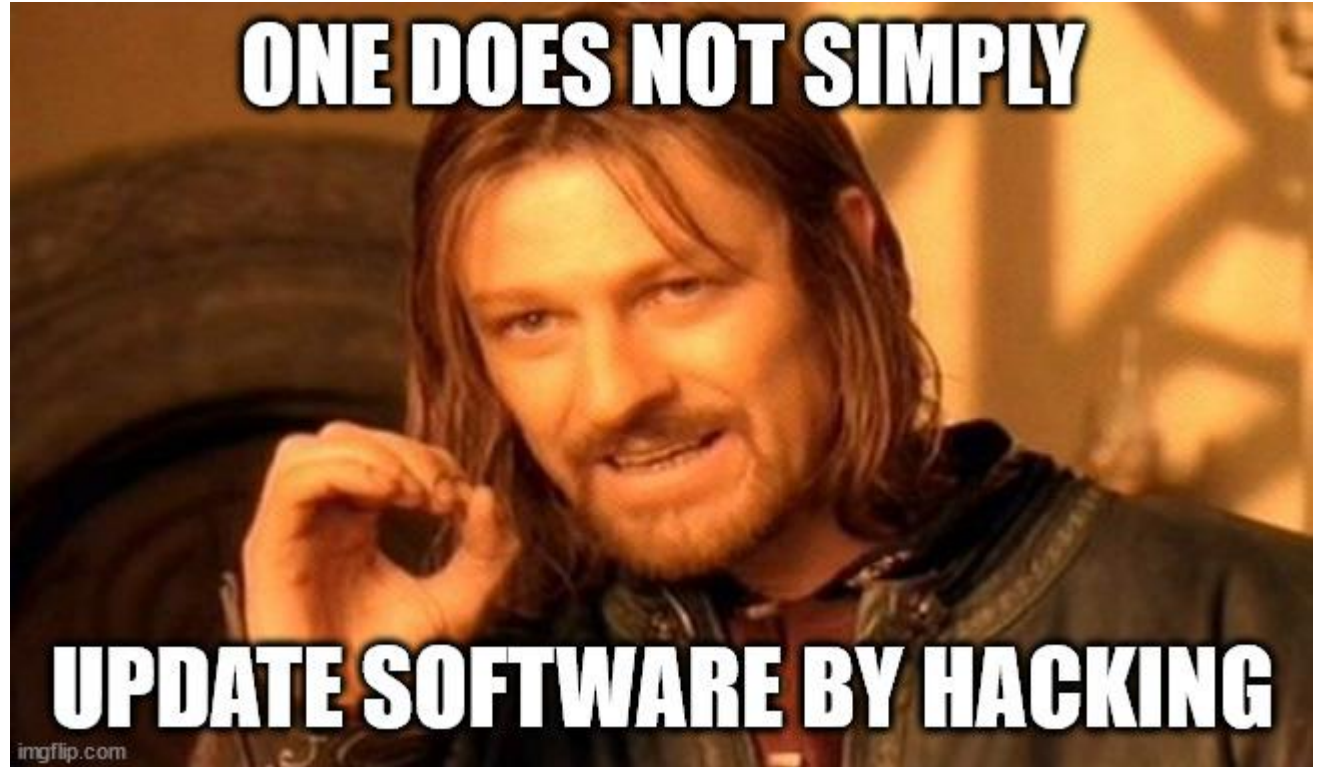



# 2015 Miller/Valasek



# 2015 Miller/Valasek





# 2015 Miller/Valasek

- Uconnect unit, running QNX
  - Sprint 3G connection
  - Open ports over wifi (D-BUS)
  - Software updates over USB for jailbreak
- 
- Two IPs per car, one for 3G services
  - Scanning 21.0.0.0/8 and 25.0.0.0/8
  - Connect, done



# 2015 Rogers/Mahaffey

- DEF CON 23
- Pentest with local focus
- VPN to Mothership
- Backdoored with SSH
- Turn of car, open doors

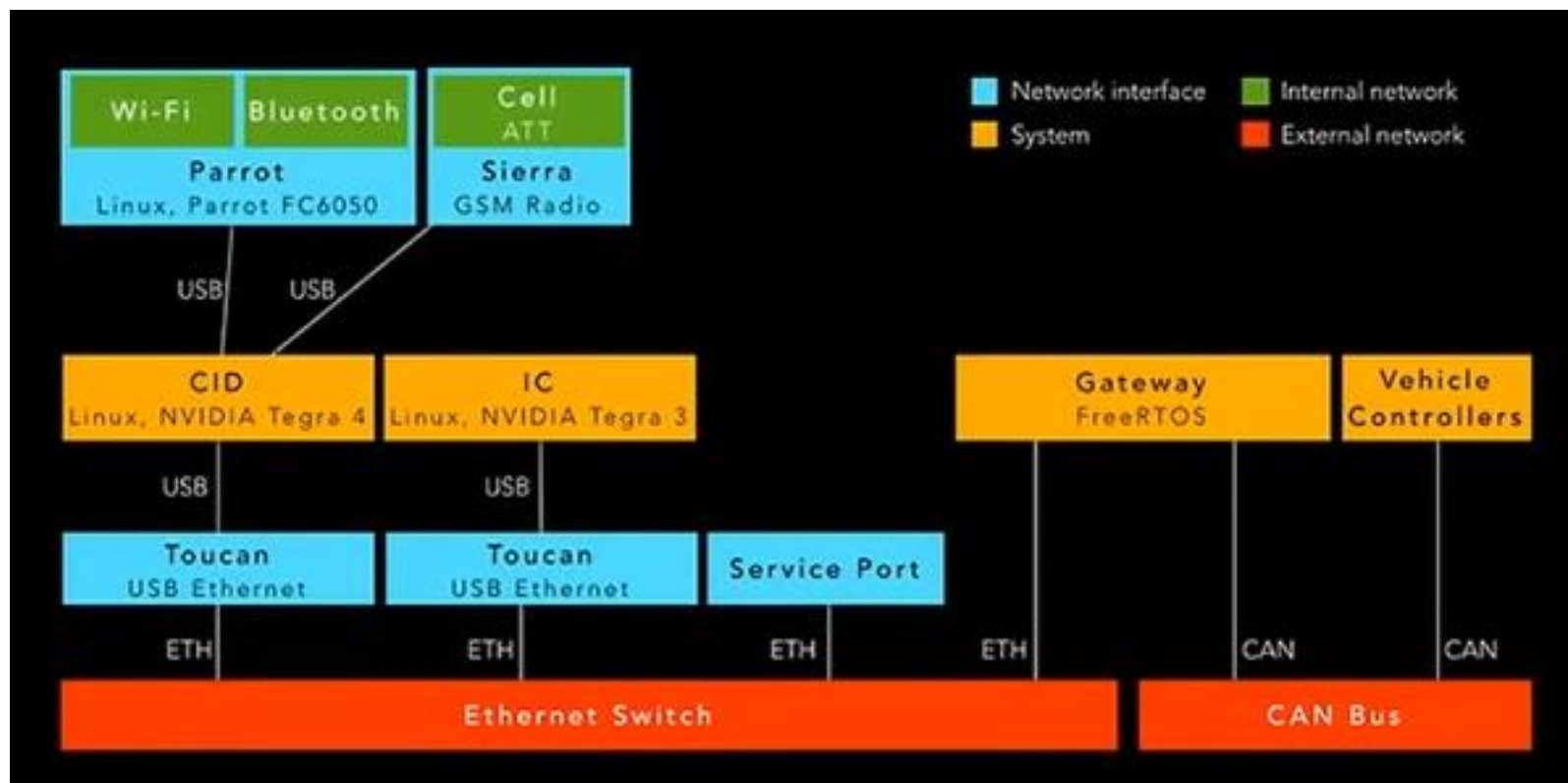

# 2015 Foster et. al

- Aftermarket OBD-II dongle
- 2G (3G for later models) and USB
- Same SSH keypair
- SSH, telnet and SSH on WAN interface
- 2k+ devices on Shodan



Remotely Applying Brakes

# 2016 Miller/Valasek

- Blackhat 2016
- Get ECU into bootrom mode
- Send conflicting messages
- Pre-date counters
- Engage brakes
- Steering
- Acceleration





# 2016 Keen Labs

- Achieved CAN sending over wifi on Tesla S
- Wifi auto connect
- Trigger webkit exploit
- Elevate privileges with known kernel vulnerability





# 2017 Keen Labs

- Presented at Blackhat 2017
- Malicious update for gateway
- Not signed – afterwards everything signed
- Pushing kernel from 2.6.36 to 4.4.35
- Xmas show



# 2018 Keen Labs

- Blackhat 2018, Tesla X
- Targeting gateway & body controller
- Kernel module for Tegra for elevating privileges
- Bypass signature verification with leading spaces
- Details on the Tesla X Xmas show



# 2018 Wouters

Required:

- Two challenges (from car)
- One response (from keyfob)



COSIC researchers hack Tesla Model S key fob

406.034 Aufrufe • 10.09.2018

👍 892    💬 MAG ICH NICHT    ➦ TEILEN    ➦ SPEICHERN    ...

# 2018 Wouters

- External supplier
- Proprietary crypto (DST40)
- Built a rainbow table with 5.6 TB

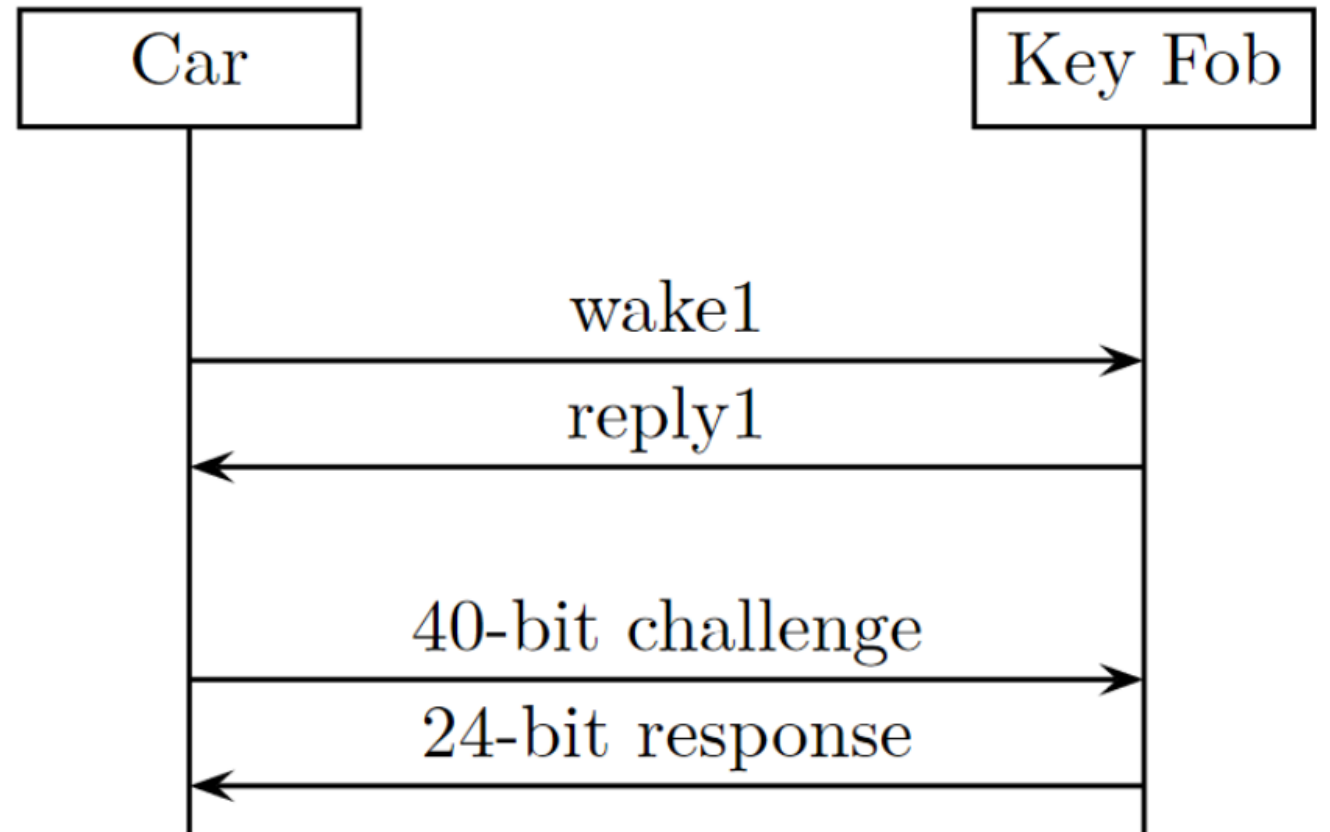



# 2019 pwn2own

- Tesla 3 infotainment running 4.14 kernel
- JIT bug in Browser
- 35,000\$

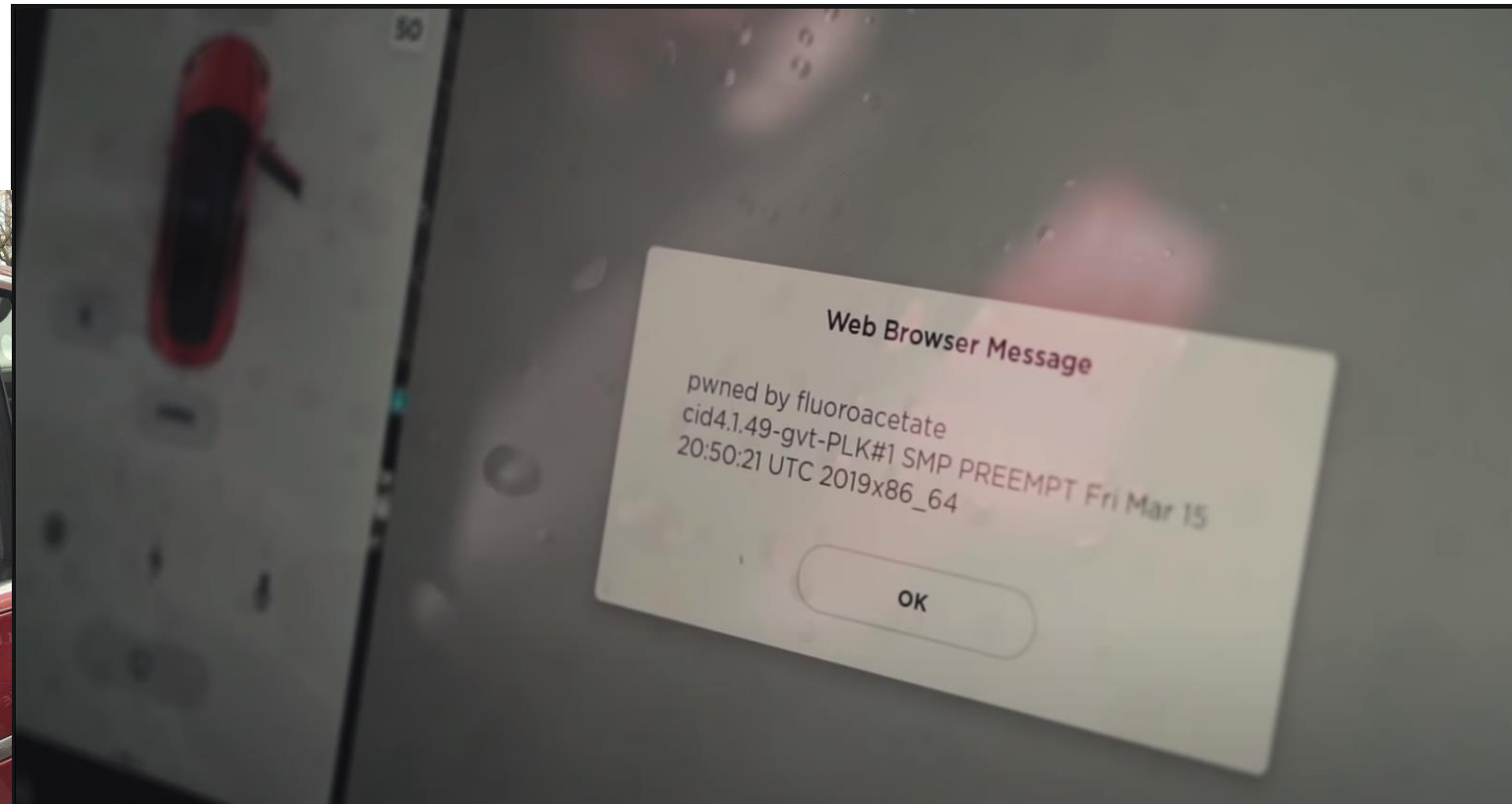



# 2019 Keenlabs

- Blackhat 2019
- 14 CVEs, some remote
- BMW head unit, gateway and telematics



No.	Vulnerability Description	Access	Affected Components	Reference
1	All the detail information has been reserved due to security concerns.	Local (USB)	HU_NBT	CVE-2018-9322
2		Local (USB/OBD)	HU_NBT	CVE-2018-9320
3		Remote	HU_NBT	Logic Issue
4		Remote	HU_NBT	Reserved
5		Local (USB)	HU_NBT	CVE-2018-9320
6		Local (USB)	HU_NBT	CVE-2018-9312
7		Remote (Bluetooth)	HU_NBT	CVE-2018-9313
8		Physical	HU_NBT	CVE-2018-9314
9		Physical	TCB	Reserved
10		Remote	TCB	Logic Issue
11		Remote	TCB	CVE-2018-9311
12		Remote	TCB	CVE-2018-9318
13		Indirect Physical	BDC/ZGW	Logic Issue
14		Indirect Physical	BDC/ZGW	Logic Issue

# 2019 Keenlabs

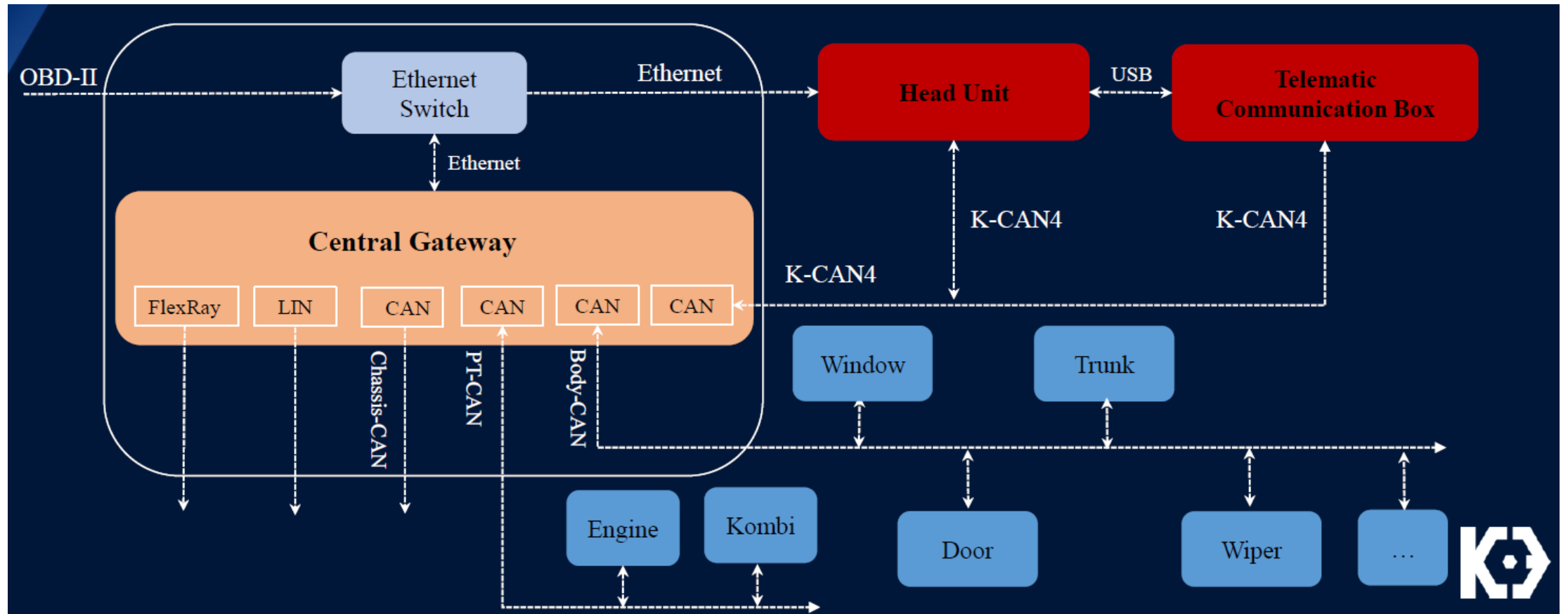

# 2020 Sky-Go 360 Group

- Blackhat 2020
- Connected Daimler cars
- 2 million cars (in China)
- Didn't succeed at WinCE 7
- But: jailbreak telematics!
- And connect to backend

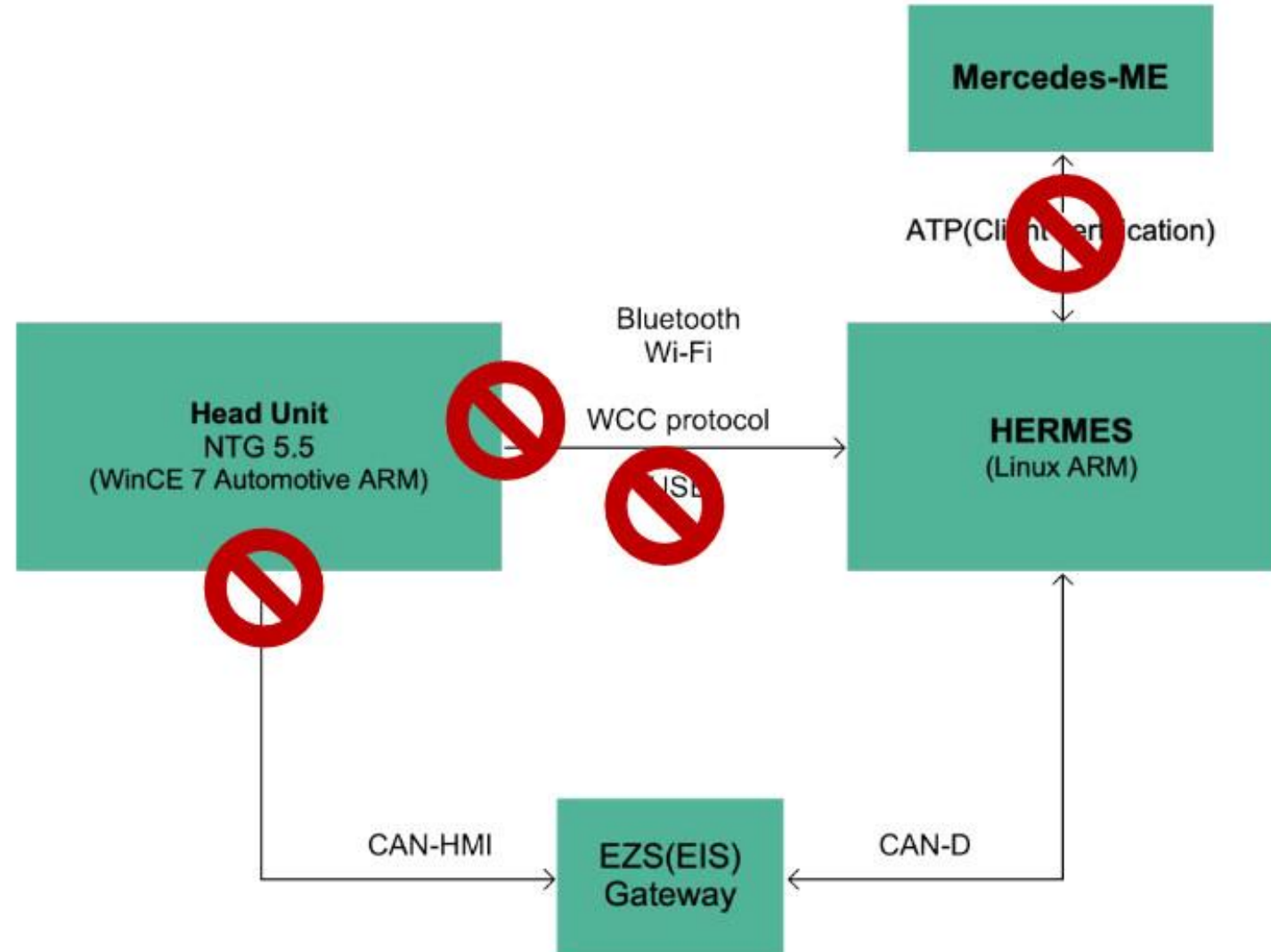

# 2020 Sky-Go 360 Group

- Used all the big tools!
- NAND reading with BGA rework station
- Theft protection reversing
- X-ray for finding JTAG
- Reballing for implanting a backdoor

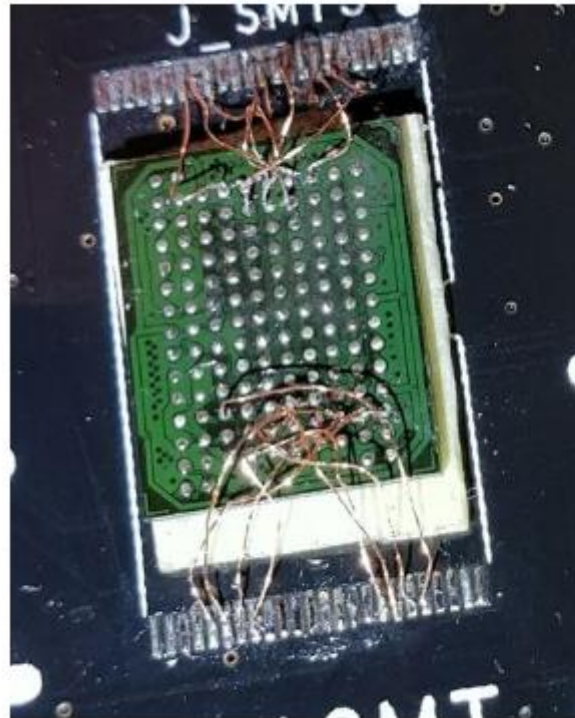

# 2021 ea\_foundation



ea @ea\_foundation · 26. Jan.



I hacked the computer in my Nissan car and so can you. Writeup and details:  
[github.com/ea/bosch\\_headu...](https://github.com/ea/bosch_headu...)

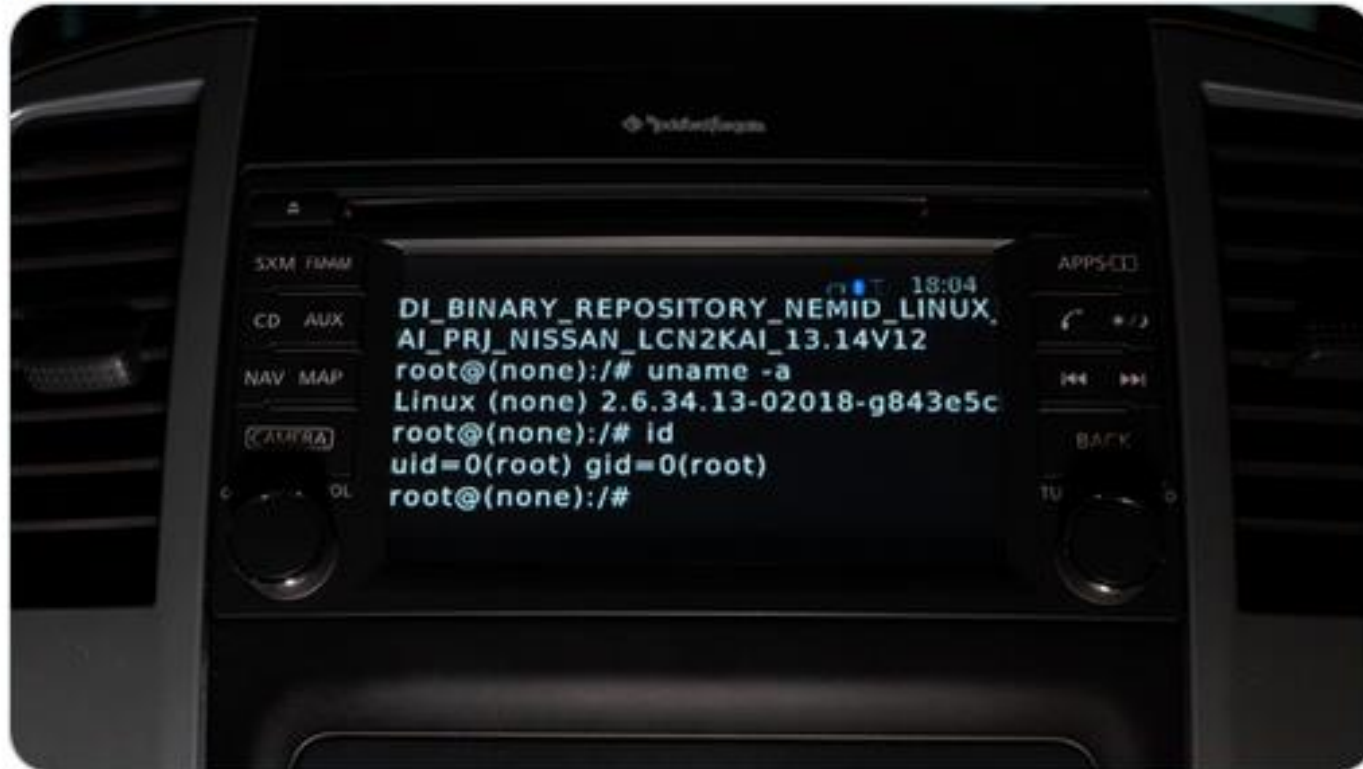

40

733

2.233





# 2021 ea\_foundation

- Rather old Bosch infotainment, 2.6-ish kernel
- Serial ports, u-boot console, read-write access
- Command injection using USB file system name

```
# Determine the name for the mount point.  First check for the
# uuid, then for the label and then for a unique name.
if [ -n "${ID_FS_UUID}" ]; then
    mountdir=${ID_FS_UUID}
elif [ -n "${ID_FS_LABEL}" ]; then
    mountdir=${ID_FS_LABEL}
```

# 2021 Lennert Wouters

ANDY GREENBERG SECURITY 11.23.2020 07:00 AM

## This Bluetooth Attack Can Steal a Tesla Model X in Minutes

The company is rolling out a patch today for the vulnerabilities, which allowed one researcher to break into one in 90 seconds and drive away.



The technique takes advantage of a collection of security issues—both major and minor—in the Model X's keyless entry system. PHOTOGRAPH: CHRISTIAN CHARISZI IMAGES



The video player displays a technical diagram of a Tesla Model X key fob. The diagram is a green printed circuit board (PCB) with various components labeled:

- Model X key fob** (overall title)
- Infinion SLM97CFX1M00PE CC EAL5+ certified** (main microcontroller)
- ADXL362B Accelerometer** (motion sensor)
- TI CC2541 Bluetooth LE MCU** (Bluetooth module)
- TI CC2590 2.4 GHz range extender** (radio module)
- MAX 2153E 22 kHz Transponder** (transponder chip)
- PCBA: 1040598** (PCB assembly number)
- ~25mm** (height dimension)

The video player interface includes a video thumbnail for "DEFCON 29" by Lennert Wouters, a progress bar at 2:12 / 26:57, and a video player control bar at the bottom.

My other car is your car: compromising the Tesla Model X keyless entry system - Lennert Wouters

477 Aufrufe · Premiere am 07.08.2021

17 0 TEILEN SPEICHERN ...

# 2021 Lennert Wouters

How the attack works:

- Wake up BLE interface of keyfob using VIN
- Flash software update to extract unlock token(s)
- Updated signed, but response ignored
- Attach to body computer
- Train new keyfob

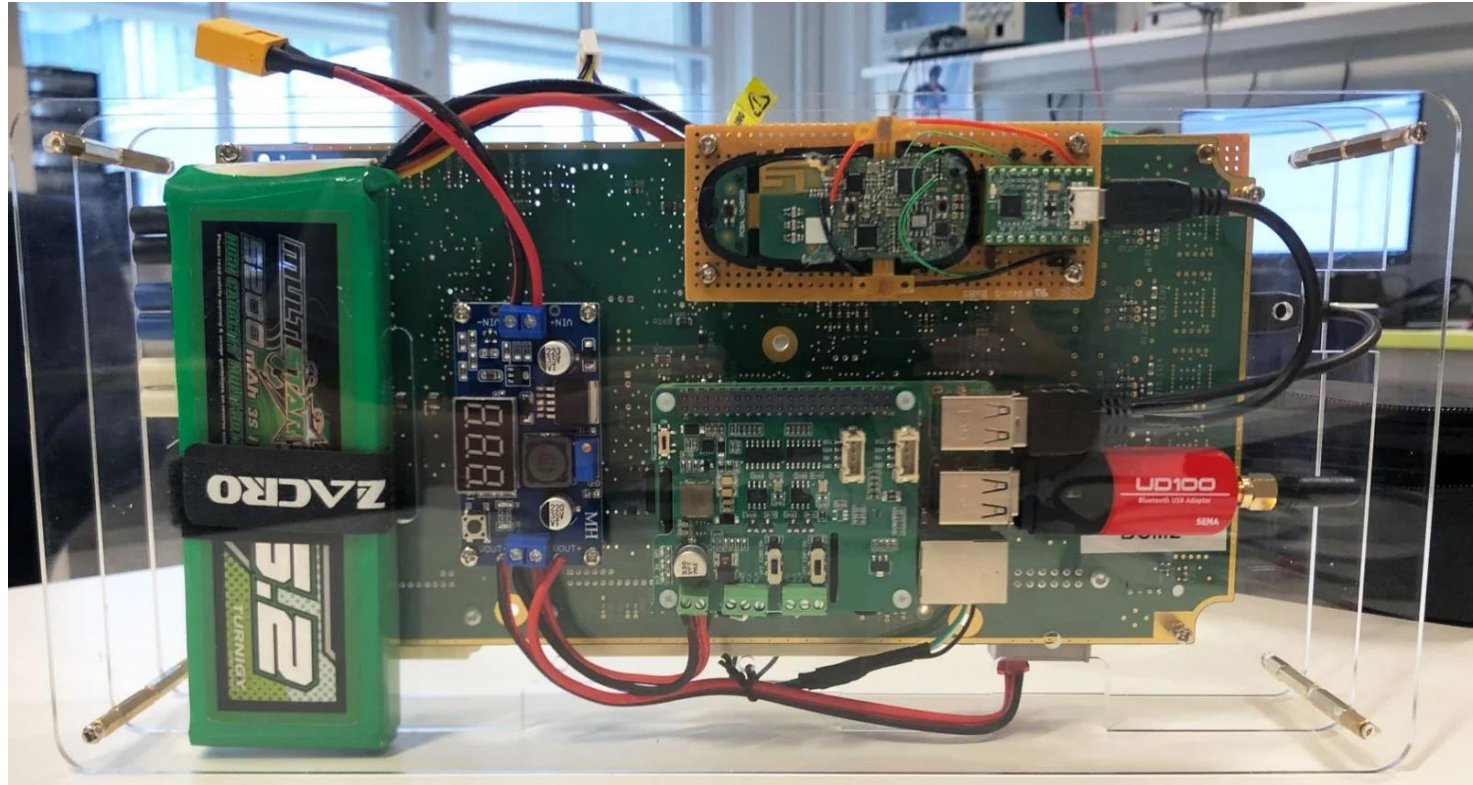



# 2021 Weinmann/Schmotzle

- Talk at CanSecWest 2021
- *TBONE*, with a drone
- memcpy() stack overflow in ConnMan
- Exploitable over wifi
- Privilege escalation using kernel module?





# 2021 Keen Labs

- Daimler MBUX headunit
- Headunit and T-box connected
- Private WPA2-encrypted wifi
- Proprietary HiQnet protocol with buffer overflow(s)
- 3.18-ish kernel



# 2021 Keen Labs

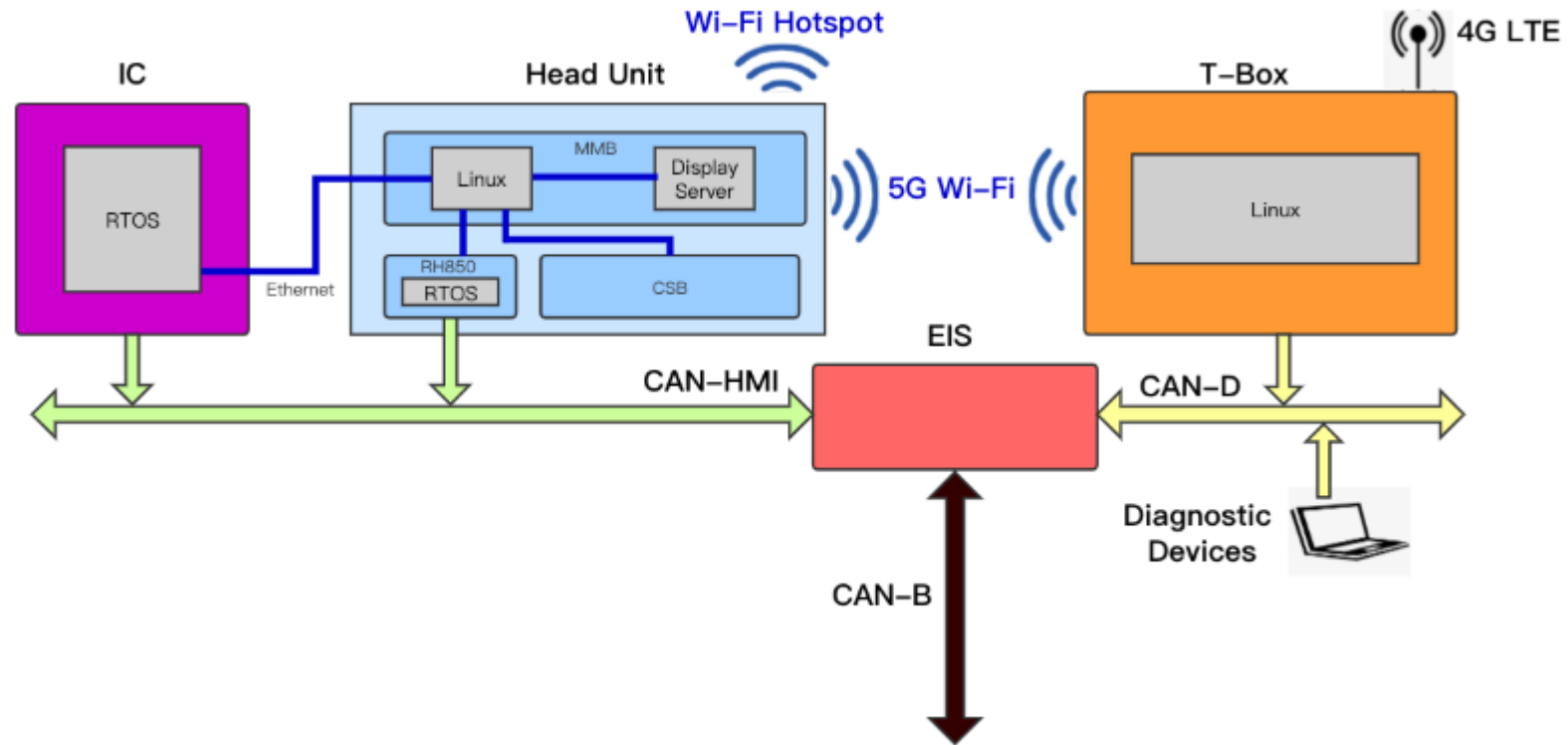
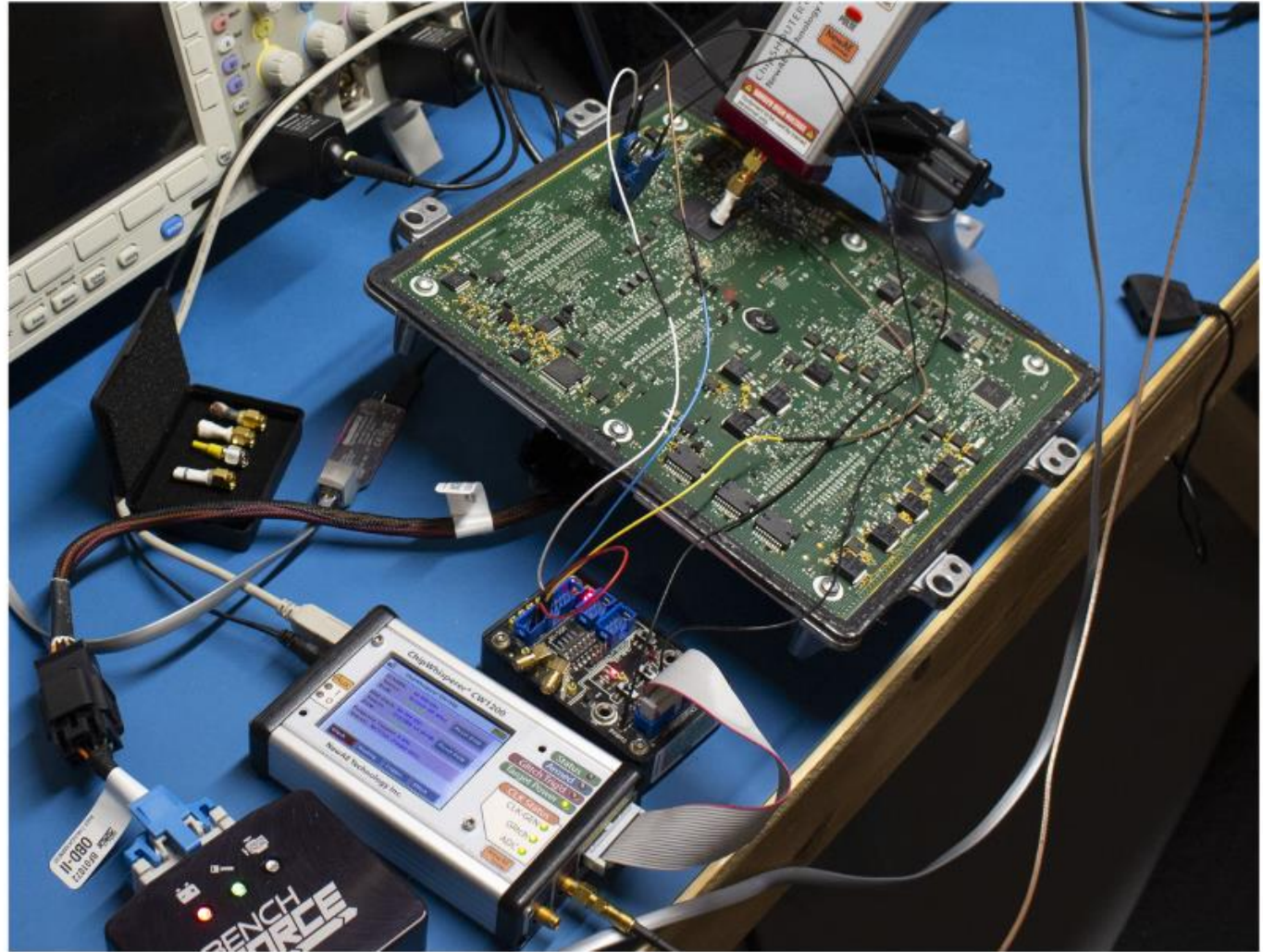

Figure 2.1: Architecture overview

# 2021 O'Flynn

- Blackhat 2021
- Glitching ECUs to bypass UART password
- Corvette E41 engine controller
- $\mu$ C was NXP MPC55x



(c) E41 ECU “In-Situ” Target



# 2022 Melching

- Steering ECU from 2008
- ReadMemoryByAddress
- Update files
- Pipe into Ghidra
- Identify bootloader & flash your customizations



Willem Melching  
@PDOWM



Wrote a four part blog series on modifying the firmware on a VW Golf power steering. It describes obtaining the FW, reverse engineering, and flashing it back with mods. Also included a bunch of general car hacking tips & tricks. [blog.willemmelching.nl/carhacking/202...](https://blog.willemmelching.nl/carhacking/202...)



5:13 nachm. · 2. Jan. 2022 · Twitter Web App

403 Retweets 30 Zitierte Tweets 1.633 „Gefällt mir“-Angaben



# 2022 Synactiv

- Pwn2own in May
- 3 vulns, 1 known
- But no writeup yet



# 2022 Argus



# 2022 Argus

- Talk at Blackhat Asia 2022
  - Instrument cluster with some Renesas RH850
  - Buffer overflow over CAN-FD
  - Leak keys, execute shell code
  - Make them lights blink
- 
- Hat tip to [@we155\\_n](#)

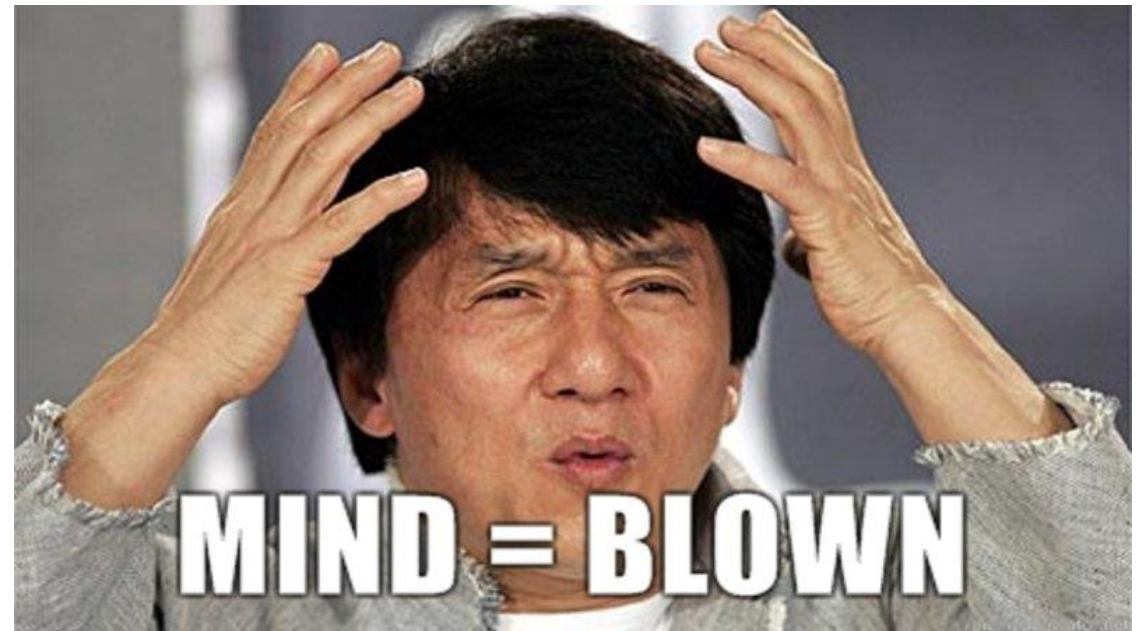



# 2022 Herfurt

- CanSecWest 2022 BLE relay against Tesla 3
- Wirelessly, over Internet
- Two other groups, about the same time

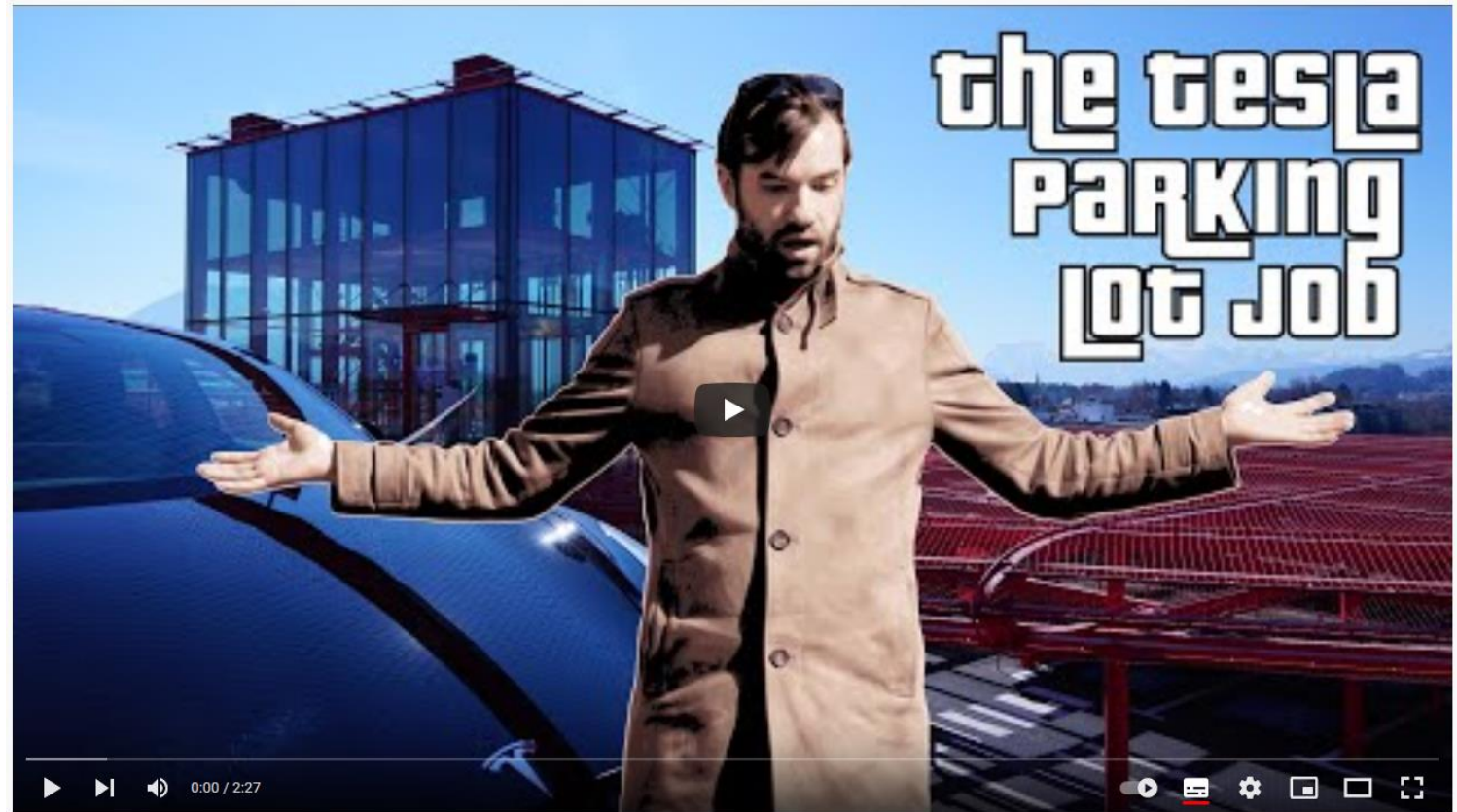

EUROPARK  
The TESLA Parking Lot Job

2.266 Aufrufe · 18.05.2022

👍 49    🗑️ MAG ICH NICHT    ➦ TEILEN    ⚙️ SPEICHERN    ...



2022 (like, yesterday!) Herfurt



# 2022 (like, yesterday!) Herfurt

- NFC unlock allows phone pairing
- No user notification
- Limited to 130 seconds
- Close proximity required
- Better use pin2drive



FIN

**!!! DO NOT HACK CARS, YOU MIGHT  
HURT YOURSELF, OR OTHERS !!!**

How to keep informed?

- Twitter, obviously
- Car Hacking Village
- Automotive security research group (ASRG.io)

**ASRG**

